



16-10-2009

SUNEA 50 SCREEN io 17rpm TECHNICAL DATA MOTOR

SDEV-CLU-IMPS 61R0

SDEV- FICA 58R0  
SUNEA 50 SCREEN io 17rpm  
Range 1

Type of head	Star Head
Nominal voltage	230 V - 50 Hz
Power supply tolerances	205-255 V AC
Thermal time	4 minutes
Number of wires of the cable	3
Wire section	0,75 mm <sup>2</sup>
Type of limit switch unit	Electronic
Capacity of the LSU	241 turns
Repeatability	< ± 5°
System of protection	IP 44
Interface drawings	Screw implantation for LT50 mounting 206810-Wheel interface LT50 206821-Crown interface LT50 206822-Interface drawing star head LT50 and LT50PA/PS 206823
Radio frequency	868-870 Mhz (tri band)
Coding	Code with a minimum of 2 <sup>48</sup> possibilities
Capacity of memory	Maxi 9 for 1W transmitter - infinite for 2W transmitters
Antenna	Integrated
Range	20 m with 2 reinforced concrete walls to be passed through Possibility to enhance radio range thanks to a Repeater
R&TTE (Radio Equipement and Telecommunications Terminal Equipement Directive)	Dir 1999/5/CE dated 1999-03-09 / CE declaration available on <a href="http://www.somfy.com/">www.somfy.com/</a> CE
Principle	The principle of the Sunea io is to motorize vertical screen application with the io-Homecontrol protocol
Basic crown for tube Ø	50 x 1,5 mm
Temperature working range	80% of life time between -10°C to +40°C 20% of life time between -20°C to +70°C

	Nm	rpm		mm	mm	mm	W	A	kg	mm	°C		dBA
Designation	Nominal torque	Nominal speed	Reference	L1 max.	L2 (±3 mm)	L3 max.	Rated power	Rated current	Weight	tube	Thermal tripping	Brake type	Noise
SUNEA SCREEN 50 io 6/17	6	17	5063115	605	590	613	90	0.45	1.85	540	140	Sliding	47
SUNEA SCREEN 50 io 10/17	10	17	5063116	655	640	663	120	0.5	1.985	590	140	Sliding	47
SUNEA SCREEN 50 io 15/17	15	17	5063117	655	640	663	140	0.65	2.12	590	150	Sliding	50

Neutral	Blue
Live	Brown
Earth	Green / Yellow

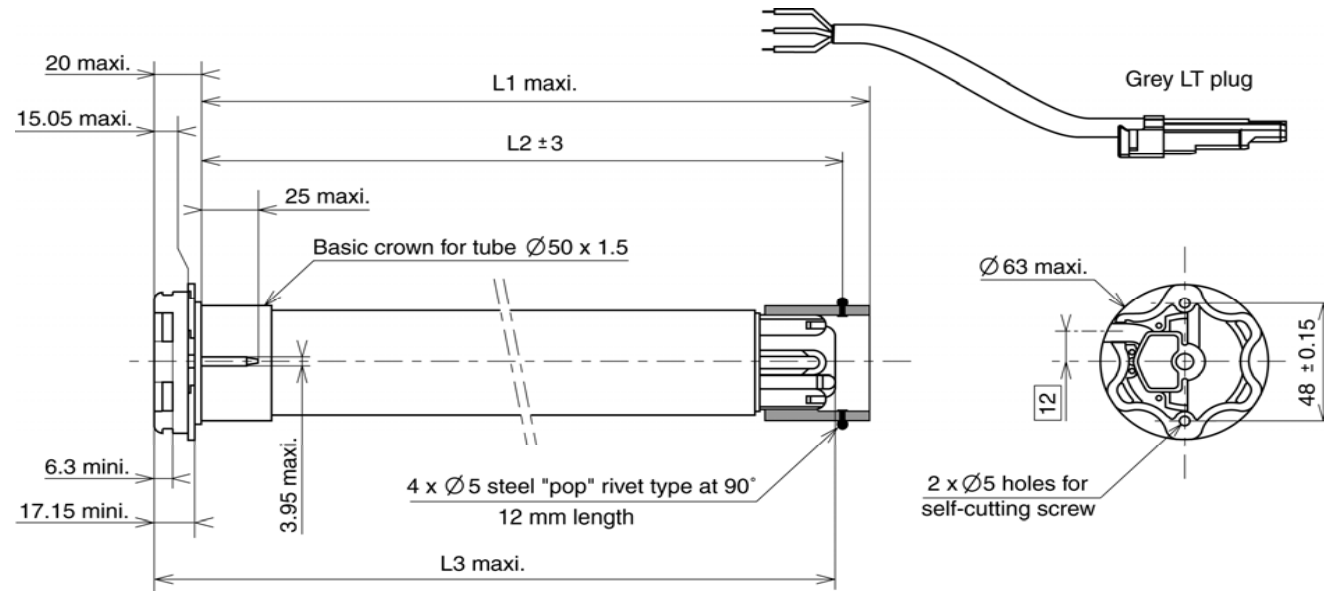

Name Date	R&D	QUALITY	EDITOR